

Inverter Driven Heat Pump

12,000 BTU Compact Cassette Type

Job Name _____
 Location _____
 Engineer _____
 Submitted To _____
 Submitted By _____
 Reference _____

Date _____
 Approval _____
 Construction _____
 Unit No _____
 Drawing No _____

PRODUCT FEATURES

- Automatic airflow adjustment
- Auto/Cool/Dry/Fan/Heat/modes
- 24 Hr. timer
- Powerful mode
- Fresh Air Knockout
- Fresh Air Kit
- Auto changeover
- Cold prevention
- Compact size - Grid fit



MODEL NUMBERS

| | |
|------------------|-------------|
| Indoor Unit | ACUH12LUAS1 |
| Nominal Capacity | 12,000 |

LINESET REQUIREMENTS

| | | |
|-------------------|----------|----------------------------|
| Connection Method | | Flare |
| Liquid | in (mm) | Ø1/4 (Ø 6.35) |
| Gas | | Ø3/8 (Ø9.52) |
| Drain hose | Material | PVC |
| | in | Ø 1 (I.D.), Ø 1-1/4 (O.D.) |
| | mm | Ø 25 (I.D.), Ø 32 (O.D.) |

INDOOR DIMENSIONS & WEIGHT

| | | |
|-------------------|---------|---------------------------|
| Net (H x W x D) | in | 9-5/8 x 22-7/16 x 22-7/16 |
| | mm | 245 x 570 x 570 |
| Gross (H x W x D) | in | 10-7/16 x 28-3/4 x 24-5/8 |
| | mm | 265 x 730 x 625 |
| Net Weight | lb (kg) | 33 (15) |
| Gross Weight | | 40 (18) |

ELECTRICAL SPECIFICATIONS

| | | |
|-------------------------|---|-------------------|
| Voltage/Frequency/Phase | | 208/230 V ~ 60 Hz |
| Voltage Range | | 187-264 V |
| Running Current | A | 0.19 |
| Input Power | W | 23 |

SOUND PRESSURE

| | | | | |
|-------------|---------|--------|--------|----|
| Indoor Unit | Cooling | High | dB (A) | 37 |
| | | Medium | | 33 |
| | | Low | | 31 |
| | | Quiet | | 28 |
| | Heating | High | dB (A) | 37 |
| | | Medium | | 33 |
| | | Low | | 31 |
| | | Quiet | | 28 |

FAN DATA

| | | | | |
|--------------|---------|--------|------------|-----------|
| Airflow Rate | Cooling | High | CFM (m3/h) | 359 (610) |
| | | Medium | | 312 (530) |
| | | Low | | 277 (470) |
| | | Quiet | | 241 (410) |
| | Heating | High | CFM (m3/h) | 359 (610) |
| | | Medium | | 312 (530) |
| | | Low | | 277 (470) |
| | | Quiet | | 241 (410) |

Warranty Information



7 Year Compressor, 5 Year Parts out-of-the-box Warranty



10 Year Compressor, 10 Year Parts Warranty when registered within 60 days of installation in a residence



12 Year Compressor, 12 Year Parts Warranty when registered within 60 days of installation in a residence, and installed by a Fujitsu Elite contractor

ENCLOSURE

| | | |
|-----------|----------|-------------|
| Enclosure | Material | Polystyrene |
| | Color | White |

ACCESSORIES

| | |
|------------------|----------------------------|
| UTY-XWZXZG | External Connect Kit |
| UTY-TFSXZ2 | Wireless LAN Interface |
| UTY-RNRUZ Series | Wired Remote Controller |
| UTY-RHRY | Simple Remote Controller |
| UTY-RSRY | Simple Remote Controller |
| UTY-LNTU | Wireless Remote Controller |
| UTZ-VXAA | Fresh Air Intake |
| UTR-YDZB | Air Outlet Shutter Plate |
| UTZ-VMSX | MODBUS Converter |
| FJ-AC-BAC-1L | BACnet Gateway |
| UTG-CCGFGA | Cassette Grille |



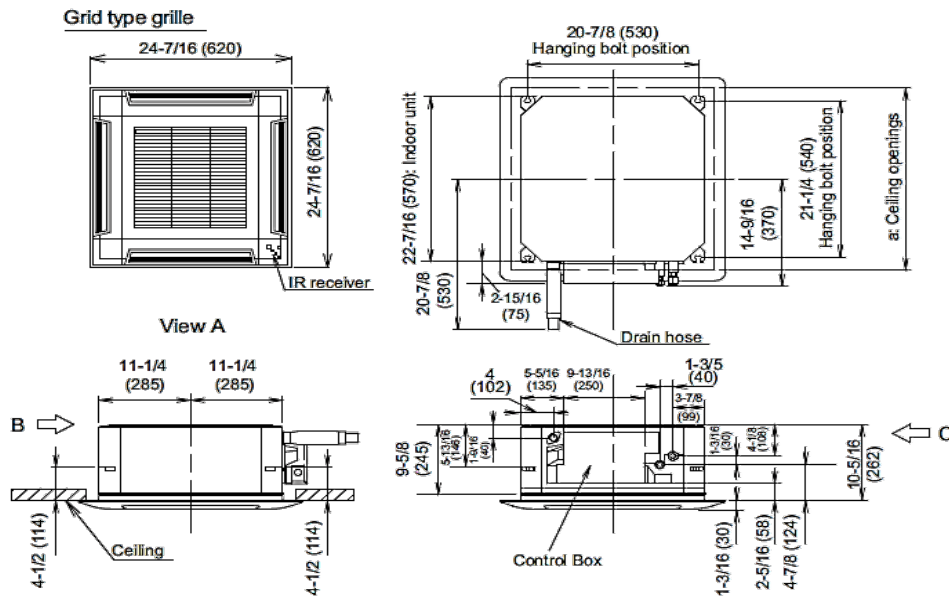

■ Installation space requirement

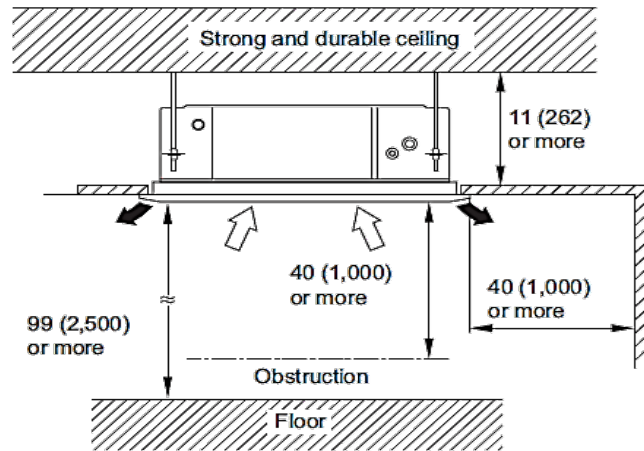

The Fujitsu logo is a worldwide trademark of Fujitsu General Limited. The Halcyon logo and name is a worldwide trademark of Fujitsu General America, Inc. Fujitsu's products are subject to continuous improvements. Fujitsu reserves the right to modify product design, specifications and information in this brochure without notice and without incurring any obligations.

Note: Specifications are based on the following conditions:
 Cooling: Indoor temperature of 80°F (26.7°C) DB/67°F (19.4°C) WB, and outdoor temperature of 95°F (35°C) DB/75°F (23.9°C) WB. Heating: Indoor temperature of 70°F (21.1°C) DB/60°F (15.6°C) WB, and outdoor temperature of 47°F (8.3°C) DB/43°F (6.1°C) WB. Pipe length: 25ft. (7.5m), Height difference: 0ft. (0m) (Outdoor unit - indoor unit).